

helmi.pdf

by

Submission date: 23-Jul-2020 10:43AM (UTC+1000)

Submission ID: 1360991990

File name: helmi.pdf (665.55K)

Word count: 3250

Character count: 18089



1
**The use of metacognitive knowledge patterns to compose
physics higher order thinking problems**

Helmi ABDULLAH¹, Jasruddin D. MALAGO², Patta BUNDU³, and Syamsul
Bachri THALIB⁴

12
¹Ph.D student, State University of Makassar, INDONESIA

²Department of Physics, State University of Makassar, INDONESIA

³Department of Elementary Teacher Education, State University of Makassar,
INDONESIA

⁴Department of Educational Psychology, State University of Makassar,
INDONESIA

3
E-mail: drshelmimsi@gmail.com

Received 13 Sept., 2013

Revised 21 Dec., 2013

Contents

- o [Abstract](#)
 - o [Introduction](#)
 - o [Theoretical Framework](#)
 - o [Procedure and Discussion](#)
 - o [Solution to escalator kinematics problem](#)
 - o [Conclusion](#)
 - o [Recommendation](#)
 - o [Reference](#)
-



Abstract

The main aspect in physics learning is the use of equation in problem solving. Equation is a mathematical form of theoretical statements, principles, and laws in physics, and describes a relationship between one concept to another by using a specific symbol. In a context of knowledge dimension, equation is a procedural knowledge. Students are required to master a lot of equations in order to solve physics problems and assist them in developing their higher order thinking skills. In reality, there are many physics teachers who are unable to produce higher order thinking problems for students' exercises. The reason is due to the lack of technical guidance on how to create physics higher order thinking problems. This study investigated a simple technical guidance to produce physics problems which suitable for helping students in enhancing their higher order thinking skills. The guidance is called metacognitive knowledge pattern. This study has successfully developed three knowledge patterns which can be used to compose physics higher order thinking problems namely triangular, rectangular, and hexagonal patterns.

Keywords: metacognitive knowledge, higher order thinking, metacognitive knowledge pattern

Introduction

In accordance with the regulation of National Education Ministry No. 26 Year 2007, the main task of a teacher is to prepare instructional materials which accommodate higher order thinking skills. This indicates that the learning materials developed by teachers are expected to enhance this skill. One important component of learning material which received less attention by teachers is the development of higher order thinking problems for students' exercise. The exercise problems provided by teachers were oriented mainly on the development of low level thinking skill. Results of questionnaire on physics instruction given to 38 high schools teachers at Soppeng District showed that 80.5% of teachers used problems available at students' textbook, 19.5% of teachers composed problems by themselves utilizing students' textbook as a reference. It was also found that 100% of teachers used problems which suitable only to develop comprehension and application skills of students. This indicates that



9
teachers are having difficulties in composing problems to train students in developing their higher order thinking skills (Abdullah, 2012).

Further investigation was conducted by interviewing 5 physics teachers. It was found that their difficulty in producing higher order thinking problems is due to: (1) they have never been trained to develop high order thinking problems, and (2) there is no guidance on how to develop such problems.

Based on this observation, the research team conducted a thorough investigation on problems sets available in physics textbook authored by Resnick & Halliday. This book was chosen based on its international reputation and it has been translated into many languages for physics teaching and learning.

2 Theoretical Framework

Metacognitive experts agreed that the main objective of learning is to develop higher order of thinking skills. This ability can be developed by providing students with problem solving exercises based on metacognitive knowledge (Abdullah, H & Khaeruddin, 2012). Arends (2008), Anderson & Krathwohl (2001) pointed out that metacognitive knowledge is the implementation of procedural knowledge in solving problems either in real life or problems in a form of cognitive conflict.

4
Santrock (2007) stated that metacognitive knowledge is a strategic knowledge on how and when a specific procedure is used to solve problems. Similarly, Arends (2007) mentioned that metacognitive knowledge is students' cognitive knowledge and when to use conceptual and procedural knowledge to solve problems. Torkamani (2010) pointed out that metacognitive knowledge is a knowledge used in problem solving. Balcikanli (2011) interpreted metacognitive knowledge into three types of knowledge namely declarative, procedural and conditional knowledge.

2
Some literatures differentiated the term of metacognitive and metacognition. Metacognitive is related to knowledge dimension while metacognition is coined into thinking process. Lin (2001) defined metacognition as the ability to comprehend and monitor thinking styles and its implied activity. Dawson (2008), Coskun (2010) and Shanon (2008) translated metacognition as thinking about thinking. Veenman, Wolters dan Afflerbach (2006) and Wernke, Wagener, Anschuetz, & Moschner (2011) stated that metacognition is high-order cognition about cognition. Duque, Baird and Posner (2000) mentioned that



metacognition is a process of thinking on its cognition skills, cognition strategies, and cognition tasks.

Based on experts opinion it appears that there are two important aspects of metacognitive knowledge, namely: (1) procedural knowledge, and (2) problem solving. Hence, metacognitive knowledge can be said as the usage of procedural knowledge dimension (including conceptual and factual) in solving problems particularly those related to daily life problems.

There are many benefits gained by students through the implementation of metacognitive knowledge. Kruger and Dunning (cited by Tok, Ozgan and Dos, 2010) pointed out that metacognitive knowledge is an important aspect in learning and can be used to predict academic achievement. Lin, Schwartz d and Hatano (2005) stated that metacognitive knowledge is used to assist students to monitor and control the effectiveness and accuracy of their understanding as well as their solving problem skills. Christine (cited by Kim, Park, and Baek, 2009) explained that metacognitive knowledge is important in enhancing the level of higher order thinking.

Generally, metacognitive knowledge is a nutritious substance for human brain. Therefore, in order to reach the level of higher order thinking skills, students must be trained through various problems based on metacognitive knowledge, one of them by using higher order thinking exercises.

Physics is a unique subject taught in school and required the whole human potentials available to learn it. One of the most prominent potential required in studying physics is logical thinking. Student who knows physics has a certain level of logical thinking and this is closely related to higher order thinking skills.

An indication that physics contained logical thinking is reflected from the IF–THEN relationship. For instance, IF a car is braked, THEN it will stop. IF a stone is thrown from a high place, THEN it will fall freely, and so on. IF-THEN relationship in physics describes two conditions, initial and final condition. These two conditions are connected by a procedural knowledge. An example for this is in the following problem.

Problem 1

A car is moving at a speed of 60km/h. How far the car has moved in one second when the driver looked at the side of the road where an accident occurred (Source, Resnick & Halliday, 1989)



The solution of this problem can be done by drawing a logical sketch as follows:

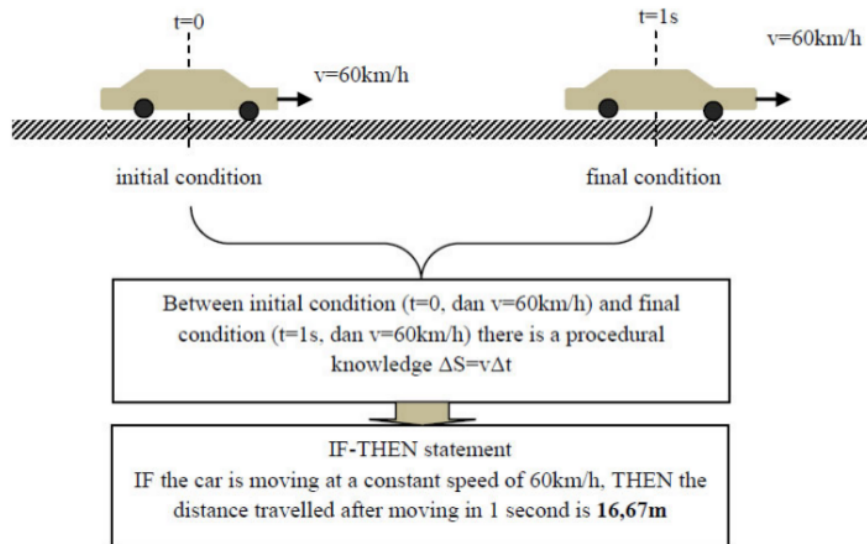

Figure 1. Logical sketch of problem 1

The use of logical sketch is not only making student to be easier in determining principle, law, and equation, but also train students to use their logic and hence improving their thinking skill systematically. It can be seen that the logical sketch has a certain pattern of metacognition knowledge. This pattern is related to the problem solving technique by using an equation. As an illustration for the above problem, its knowledge pattern is pictured as follows,

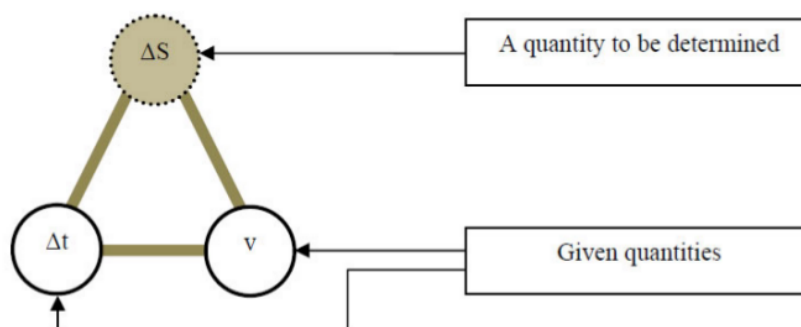

Figure 2. The metacognitive knowledge pattern (triangular type)



The use of Δ in S and t indicates the change of position and time from initial to final condition, while v without Δ indicates constant velocity. Triangular type is a basic pattern describing one procedural knowledge. This pattern is commonly used by teachers in designing problems for students' exercises as it is very simple and suitable to train basic knowledge operation but it will be very difficult to be developed into higher order thinking problems.

The development of metacognitive knowledge pattern was studied by analyzing a solution of escalator kinematic problem. A problem in a physics textbook written by Resnick & Halliday was used for this purpose and it is explained in following discussion.

Procedure and Discussion

Based on the procedure developed in this research, physics textbook written by Resnick & Halliday was selected to be studied. The book was chosen simply because of it is widely used as a main reference in teaching physics in Indonesian universities and other countries. Besides that, problems provided in this book were arranged systematically based on the level of difficulties.

The next step was studying problems about motion in one dimension at constant velocity. It was found that there is one problem required higher order thinking skill. This problem is related to escalator kinematics as follows.

A person is walking upwards in a rest escalator. She arrives on top of the escalator in 90s. If she just standing and the escalator is moving she arrives on top in 60s. How long does she will take to reach top while walking in a moving escalator? (Source: Resnick & Halliday, 1997)

International Physics Education students. The results showed that 90.77% of students were unable to answer the question correctly. The rest 9.23 % of students answered the question correctly but their answers were not equipped with logical sketch similar to the following sketch provided by the team.

Solution to escalator kinematics problem

It is clear that there are three different motion systems in this problem. The logical sketch and its knowledge pattern can be drawn as follows:

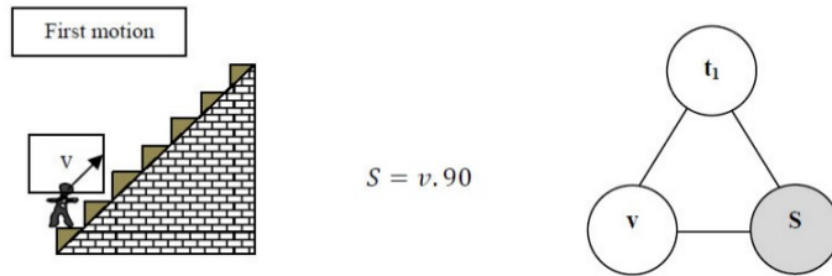

Figure 3.a. Logical sketch and knowledge pattern for the first case

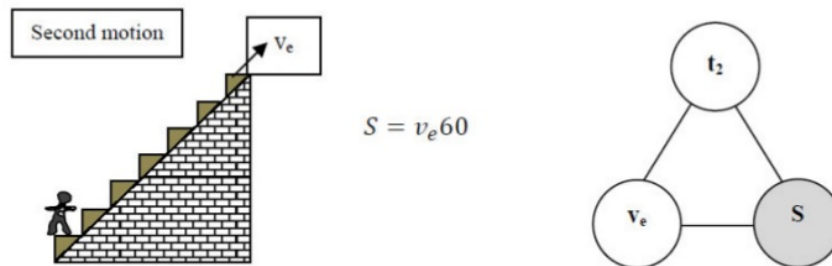

Figure 3.b. Logical sketch and knowledge pattern for the second case

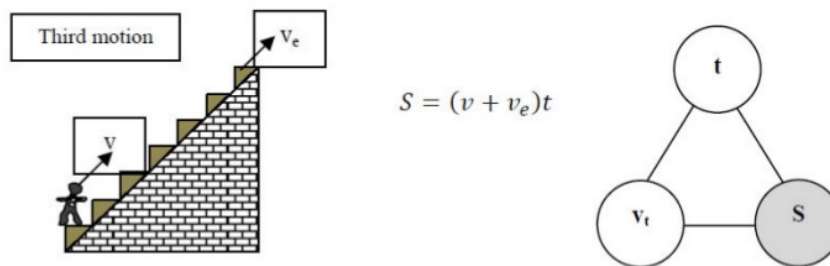

Figure 3.c. Logical sketch and knowledge pattern for the third case

Substituting the first equation into the second equation, it gives:

$$\frac{v_e}{v} = \frac{3}{2} \dots (2)$$

Then, the second equation is substitute into the third equation, it gives:



$$\frac{v+v_e}{v_e} = \frac{60}{t} \dots (3)$$

From equation (2) and (3) we will have $t = 36\text{s}$. So, the time she need to reach the top of escalator is 36 s.

Based on the analysis results of escalator kinematics problem, triangular type was found in every case. If all triangular patterns is combined and S is used as correlation quantity (the height of escalator is the same for each case), it result in a new pattern as depicted in Fig. 4.

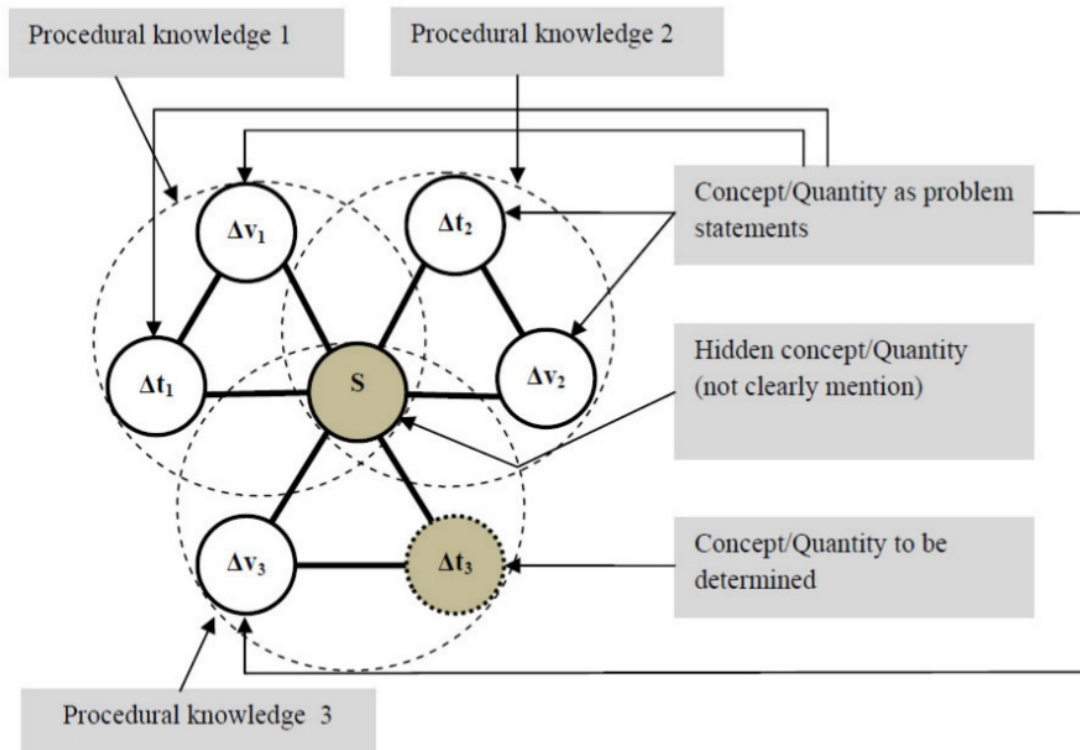

Figure 4. Hexagonal pattern

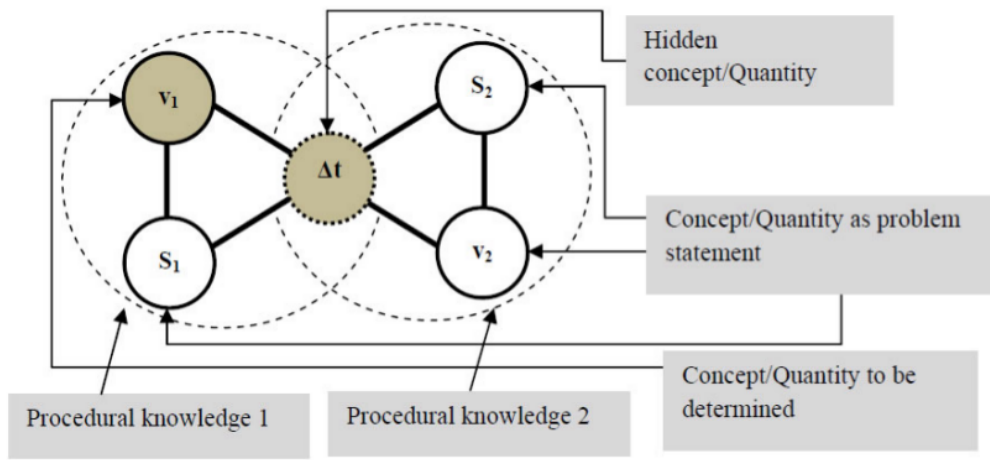

Figure 5. Rectangular pattern

Based on three design of knowledge pattern mentioned above, each pattern can be defined as follows: (1) triangular pattern is a basic pattern which contain only one procedural knowledge, (2) rectangular pattern is a pattern which contain two types of procedural knowledge, and (3) hexagonal pattern is a pattern which contain three types of procedural knowledge. For rectangular and hexagonal pattern, their procedural knowledge can be similar or different types.

The next problem is how to design problems for higher order thinking exercises by using the aforementioned knowledge pattern. As an example, rectangular pattern with two different procedurals knowledge will be developed. For instance, a problem which connected two different equations, its procedure is as follows.

1. Established procedural knowledge, for example:

$$\boxed{F = ma} \longleftrightarrow \boxed{a = \frac{\Delta v}{\Delta t}}$$



2. Create knowledge pattern, such as

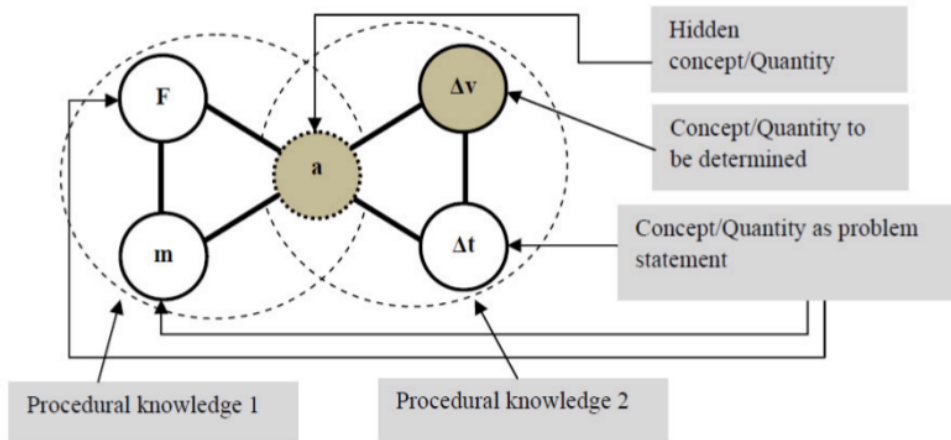

Figure 6. Techniques to design problem based on rectangular pattern

3. Determine the quantity or concept to be the statement, hidden or asked. For instance, the problem statement are F , m , and Δt , while a is hidden quantity, and Δv is a quantity to be determined.

4. Draw a logical sketch, such as in Fig. 7

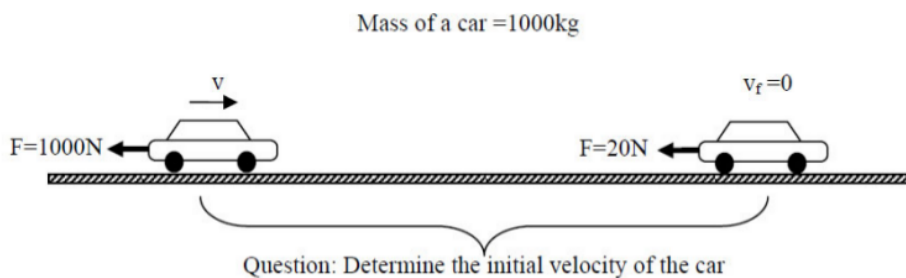

Figure 7. Logical sketch to design problem for student exercise

5. Develop problem, for the above case, the problem can be stated as follows.

A car is moving with constant velocity on a straight road. The driver is suddenly slammed on brakes with a force of 1000N when he sees an accident blocking the road. He noted that it take



20s to stop the car in front of the accident site. Determine the velocity of the car at the time the driver slammed on brakes.

In the process of problems development the use of box like the above examples is not important and teachers can create their own style. They can develop problem modes which appropriate or suitable with their students' environment such as hole on the road, a cat or a herd of cattle crossing the roads. Similarly, teachers can use examples other than a car and it is not necessary the problem that related to the road.

Conclusion

There are three basic patterns of metacognitive knowledge in physics that can be used as guidelines in the development of metacognitive questions namely triangular, rectangular, and hexagonal patterns. Each pattern has its own characteristics in measuring the ability of the thinking process. The more complex knowledge patterns used in designing problems the more higher order thinking skills that can be measured.

Recommendation

There are various knowledge and aspects which can be investigated through problems available in physics textbook of Resnick & Halliday as well as other textbooks. We encourage physics teachers to study physics problems which accommodate more complex procedural knowledge.

Reference

- Abdullah, H. (2013). *Evaluation report Sain Physics Olympiad coaching in a physics teacher Soppeng district of South Sulawesi, Indonesia*. Dinas Pendidikan, Pemuda, dan Olahraga, Soppeng.
- Abdullah, H. & Khaeruddin (2012). *Study on Metacognitive Knowledge in Student Physics Education Program, State University of Makassar*, Lembaga Penelitian UNM, Makassar.
- Anderson, L.W. & Krathwohl, D.R. (ed) (2001). *A Taxonomy for Learning, Teaching, and Assesing: A Revision of Bloom Taxonomy of Educational Objectives*. A Bridge Edition, Addison Wesley Longman, Inc.
- Arends, R.I. (2007). *Learning To Teach*. Seventh Edition, Mc.Graw Hill Companies, Inc, NY.



- Balcikanli, C. (2011). Metacognitive Awareness Inventory for Teachers (MAIT). *Electronic Journal of Research in Educational Psychology*, 9(3), No.25, 1309-1332.
- Coskun,A. (2010). The Effect of Metacognitive Strategy Training on The Listening performance of Beginner Student. *Novitas Royal*, 4(1), 35-50.
- Dawson, T.L. (2008). *Metacognition and Learning in Adulthood*. Prepared in response to tasking from ODNI/CHCO/IC Leadership Development Office. Development Service, LLC.
- Duque, D.F., Baird,J.A., & Posner,M.I. (2000). Executive Attention and Metacognitive Regulation. *Consciousness and Cogniton*, 9, 288-307.
- Kim, B., Park, H., & Baek,Y. (2009). Not Just Fun, but Serious Strategies: Using Metacognitive Strategies in Game Base Learning. *Computer & Education*, 52, 800-810.
- Lin,X. (2001). Designing Metaconitive Activities. *ETR&D*, 49(2), 23-40.
- Lin. X., Schwartz, D.L & Hatano, G. (2005). Towards Teachers' Adaptive Metacognition. *Educational Psychologist*, 40(4), 245-255.
- Regulation of National Education Ministry No. 26 Year 2007, Jakarta-Indonesia.
- Resnick, R. & Halliday, D. (1975). *Physics 3rd Edition*. John Wiley & Sons, Inc/
- Santrock, J.W. (2004). *Educational Psychology*. Second Edition, Mc.Graw Hill Company Inc. NY
- Shanon, S.V. (2008). Using Metacognitive Strategies and Learning Style to Create Self-Directed Learners. *Institute for Learning Style Journal*, 1, 14-27.
- Tok, H., Ozgan, H., & Dos, B. (2010). Assessing Metacognitive Awareness and Learning Strategies as Positive Predictors for Succes in a Distance Learning Class. *Mustafa Kamal University Journal of Social Sciences Institute*, 7(14), 123-134.
- Torkamani, H.T. (2010). On the Use of Metacognitive Strategies by Iranian EFL Learners in Doing Various Reading Task Across Different Proficiency Level. *International Journal of Language Student*, 4(1), 47-58.
- Veenman, M.V.J., Wolters, B.H.A.M., & Afflerbach, P. (2006). Metacognition and Learning: Conceptual and Methodological Consideration. *Metacogniton Learning*, 1, 3-14.
- Wernke, S., Wagener, U., Anschuetz, A. & Moschner, B. (2011). Assessing Cognitive and Metacognitive Learning Strategies in School Children: Conduct Validity and Arising Questions. *The International Journal of Research and Review*, 6(2), 19-37.

ORIGINALITY REPORT

19%

SIMILARITY INDEX

14%

INTERNET SOURCES

12%

PUBLICATIONS

16%

STUDENT PAPERS

PRIMARY SOURCES

1	sinta3.ristekdikti.go.id Internet Source	10%
2	Submitted to EDMC Student Paper	4%
3	www.eduhk.hk Internet Source	1%
4	Submitted to University of Canterbury Student Paper	1%
5	Submitted to Middlesex University Student Paper	1%
6	Submitted to American Intercontinental University Online Student Paper	1%
7	Submitted to University of Pretoria Student Paper	<1%
8	www.edusoft.ro Internet Source	<1%
9	academicjournals.org	

Internet Source

<1%

10

[studylib.net](#)

Internet Source

<1%

11

Submitted to University of Bristol

Student Paper

<1%

12

Zaidin, M. Arifin, Achmad Tolla, Muhammad Sidin Ali, and Akmal Hamsa. "Correlation between the Tutor Competency Aspects and the Results of the Students' Basic Writing Skills at Open University Makassar", Journal of Language Teaching and Research, 2014.

Publication

<1%

Exclude quotes On

Exclude matches Off

Exclude bibliography On

FINAL GRADE

/0

GENERAL COMMENTS

Instructor

PAGE 1

PAGE 2

PAGE 3

PAGE 4

PAGE 5

PAGE 6

PAGE 7

PAGE 8

PAGE 9

PAGE 10

PAGE 11

PAGE 12