

PAPER NAME

3. Artikel International_ICIC_IoT Based Power Consumption and Losses Monitoring Technique Applied in

WORD COUNT

2998 Words

CHARACTER COUNT

16602 Characters

PAGE COUNT

8 Pages

FILE SIZE

2.1MB

SUBMISSION DATE

May 17, 2023 10:35 AM GMT+8

REPORT DATE

May 17, 2023 10:36 AM GMT+8

● **4% Overall Similarity**

The combined total of all matches, including overlapping sources, for each database.

- 3% Internet database
- 2% Publications database
- Crossref database
- Crossref Posted Content database
- 1% Submitted Works database

● **Excluded from Similarity Report**

- Bibliographic material
- Quoted material
- Cited material
- Small Matches (Less than 10 words)
- Manually excluded sources

AN IOT BASED POWER CONSUMPTION AND LOSSES MONITORING TECHNIQUE FOR A MINI SCALE ELECTRICAL NETWORK

MULIADI^{1,2}, INTAN SARI ARENI¹, ELYAS PALANTEI¹, ANDANI ACHMAD^{1,*}
AND MUHAMMAD SABIRIN HADIS³

¹Department of Electrical Engineering
Faculty of Engineering
Universitas Hasanuddin

Romang Lompoa, Bontomarannu, Gowa 92171, Indonesia
{ intan; elyas_palantei }@unhas.ac.id

*Corresponding author: andani@unhas.ac.id

²Department of Electrical Education Engineering
Faculty of Engineering
Universitas Negeri Makassar

Parang Tambung, Tamalate, Makassar 90224, Indonesia
muliadi7404@unm.ac.id

³Study Program of Informatics Engineering
STMIK AKBA

Tamalanrea Jaya, Tamalanrea, Makassar 90245, Indonesia
muhammadsabirinhadis@akba.ac.id

Received August 2021; accepted November 2021

ABSTRACT. *The reported power consumption of each user does not appropriately indicate the actual electrical energy utilized for the intended purposes. The power electrical consumption profile might also be contributed by the power losses encountered in the entire mini-scale electrical network, such as house electrical power installation network, buildings, and offices. Some energy monitoring systems have been developed but have not calculated the amount of lost energy. This information is essential for analyzing energy consumption. In this paper, an Internet of Things-based energy monitoring system is built using the PZEM-004T sensor module, which can simultaneously monitor energy consumption and lost energy. After testing, the built-up monitoring system provided an incredibly high accuracy of 97.96% from the comparison results with two different conventional electrical meter units. The significant impact of using the developed energy monitoring system is that the users can simultaneously monitor the consumption and lost energy and access it from anywhere via the available Internet connection in a flexible and real-time way.*

Keywords: Energy monitoring system, Energy consumption, Power loss, Internet of Things (IoT), Sensors network

1. **Introduction.** Based on data from the U.S. Energy Information Administration (EIA), electrical energy consumption throughout the world from 2015 to 2018 has increased by an average of 5% each year [1]. In general, the uses of electrical energy are majority existing for the regular uses in building lighting, transportation, industry, and household electronic devices [2].

Consumption of electrical energy does not necessarily support the increased daily productivity, which causes energy wastage. One of the causes of energy wastage is that users have difficulty calculating the amount consumed every time. They cannot adequately control the use of electrical energy. In addition to difficulties, users also faced problems

boredom checking energy consumption through conventional electrical energy meter devices installed on building sites [3-5]. Lost energy is also one of the factors that cause an increase in the use of electrical energy consumption, so users need to know the amount of energy lost in their energy consumption [6-8].

The Energy Monitoring System (EMS) is a solution to face the problems to overcome users' difficulties in monitoring conventional electrical energy consumption. EMS shows energy usage digitally, making it easier for users to know the amount of energy consumption. The Internet of Things (IoT) was applied in several studies [9-15] that make the system accessible anywhere and anytime with an Internet connection. With IoT, users can be more flexible in checking their energy consumption, and several problems regarding the utilization of IoT have been solved by the techniques that have been developed [16].

Several studies have been carried out to develop an EMS. Andrade et al. [17] build a monitoring system for electrical energy consumption through a mobile application in real time using Arduino Uno as a microcontroller and LoRa EXP32 SX1278 as internal communication between other nodes. The Central Unit transmits data to the Internet using the ESP8266 module. Al-Hassan et al. [18] establish a smart power socket to monitor energy consumption of household electrical devices using Arduino Nano with Xbee module as a Zigbee communication. Gan et al. [19] build an IoT-based energy consumption monitoring system using the ABB B24 digital power meter as a measurement of energy consumption, Raspberry Pi 2 as a controller, and LoRa as the primary communication system for the industrial environment. Susanti et al. [20] develop an IoT-based electrical energy consumption monitoring system using a current sensor SCT013 and Wemos D1 as a central unit that stores data to a website application. Wasoontarajaroen et al. [21] establish an IoT device to monitor electrical energy consumption using the PZEM-004T sensor that measures voltage and current, Arduino Uno as a controller, and ESP8266 as a device that sends data to the Internet and data will be received in a mobile application.

The EMS that has been developed only focuses on monitoring energy consumption, whereas the energy lost is also an indicator that needs to be monitored to increase the effectiveness of the use of electrical energy. In this paper, an energy monitoring system is developed that can monitor consumption and lost electrical energy. After that, the accuracy of sensors on the system is tested by comparing the measurement results to electrical meter devices. With the implementation of the EMS that has been established, it is hoped that users can find out the amount of energy consumption used at any time and know the amount of energy lost. This system can help users analyze causes of energy loss beyond standard limits, increasing electricity payments, and excessive energy wastage.

Part one of this paper describes the background and related work, the second part explains about method to build the EMS, the third part discusses results and analysis, and the fourth part describes the conclusions of this research.

2. Method. The robust configuration of the constructed real-time IoT-based power consumption and losses monitoring system was schematically visualized in Figure 1. This IoT monitoring system was assembled from eight main electronic functional parts, including Miniature Circuit Breaker (MCB) unit, several electrical sensor parts, central processor unit ESP8266, the electrical appliances, IDE Arduino (#C) module, WiFi Internet connection, and the real-time dashboards power monitoring system installed both in PC Web server and Smart Phone Web applications. Two power sensors are placed on the electrical meter unit: one is placed on the MCB line to calculate energy consumption; the second is placed on the ground line to calculate energy lost. Data from the sensor will be forwarded to the central unit for processing and then sent to a web server as a sensor data storage center. Users can access consumption and energy lost data through a website application that can be accessed via the Internet. The system architecture can be seen in Figure 1.

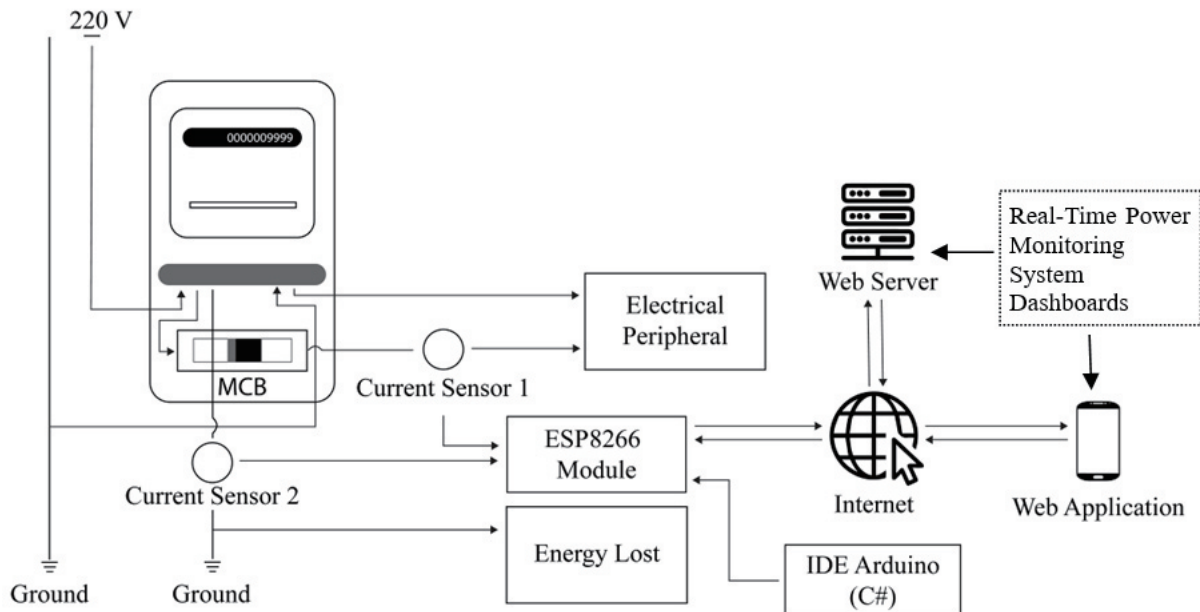

FIGURE 1. A typical architecture of real-time power monitoring system

The power sensor using PZEM-004T was applied to measuring voltage, current, and power electrical energy [22]. At the same time, Wemos D1 Mini has been embedded with the ESP8266 module [23] as a central device unit. The device receives data from sensors and later transmits it to a web server using Wi-Fi communication. This way is ideally cheaper and compatible with the whole system compared to ESP32 [24]. The series of hardware components configured is portrayed in Figure 2. Figure 3 describes that the constructed system will continuously execute the computing algorithms to generate the updated power consumption and losses, respectively. The whole monitoring system will be set up to ensure all hardware and software parts operate appropriately. The process is followed by reading the current value at the MCB module and the leakage current passing through the grounding using the PZEM-004T sensor. All recorded current data are finally fed forwardly to the Internet server for further processing on the website.

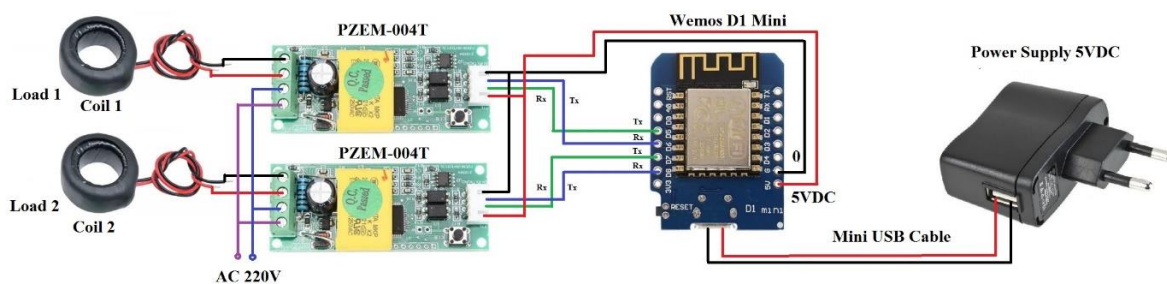

FIGURE 2. Schematic block diagram of electrical power sensing hardware

The prototype of an energy monitoring system was implemented in residential homes with 220 V, 6 A. The power capacity that can be achieved is approximately 1320 W. This study conducted two monitoring tests, namely testing on sensor accuracy for measuring energy consumption and energy lost.

1) **Energy consumption test:** PZEM-004T sensor is placed on the cable coming from the electricity meter to determine the amount of power, voltage, and current value in real time at any time so that the amount of energy consumption used can be recorded. Validation of sensor testing was also carried out by comparing the measurement results of

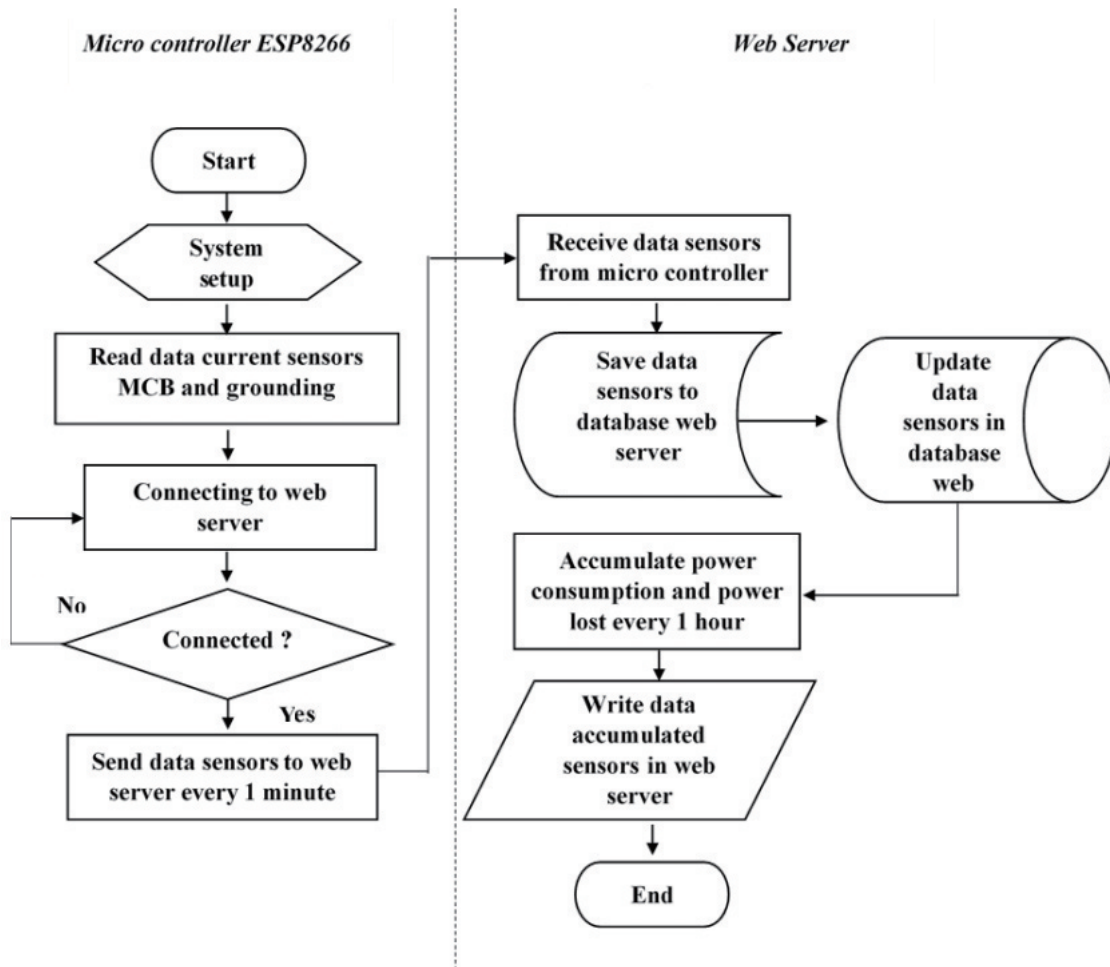

FIGURE 3. A typical computing algorithm of real-time power monitoring system

two electricity meter units with the type MELCOINDA MS-98E and MELCOINDA MF-97E using the error rate equation to determine the accuracy of the PZEM-004T sensor for calculating the amount of power every hour (kWh).

$$\text{Error Rate} = \frac{\text{Sensor Value} - \text{Electrical Meter Value}}{\text{Electrical Meter Value}} \times 100\% \quad (1)$$

2) **Lost energy testing:** The PZEM-004T sensor module is placed on a cable that goes to the ground to calculate the amount of current that occurs in real time, then multiplied by the amount of static voltage of 220 V. The result is the amount of power wasted every hour (kWh).

3. **Result and Discussion.** PZEM-004T sensor module with number one was used to calculate the amount of energy consumption, and PZEM-004T sensor module with number two was used to calculate the amount of lost energy. Both sensors are connected to Wemos D1 as Central Unit (CU) to process sensor data sent to a web server using the ESP8266 module embedded in CU. The system was equipped with energy reserves using a power bank to anticipate power outages so that the EMS could operate according to the desired purpose. The prototype was connected to two electricity meter units which are used to validate the sensor measurements. The prototype system model that has been established can be seen in Figure 4.

Users can monitor the amount of energy consumption and lost energy in real time, anywhere, and anytime through the website application that has been built. This application

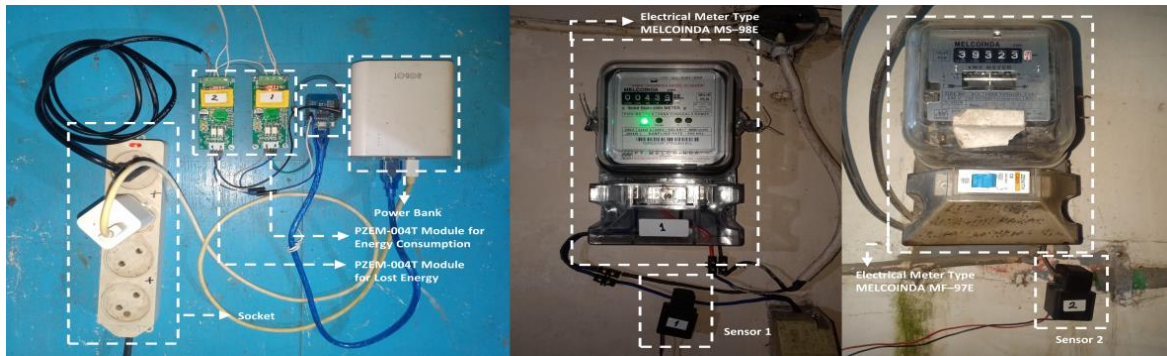

FIGURE 4. Prototype system

is designed with a simple user interface, and the data displayed follows user requirements so that users are easy to operate. The monitoring application has two menus, namely Dashboard and Overview.

1) **Dashboard:** This interface shows the power, power factor, voltage, and current value monitored in real time. The values mentioned can be seen in the amount of energy consumption used, and the lost energy is calculated. The dashboard is also equipped with a graph of energy consumption and lost energy over time.

2) **Overview:** The total value of energy consumption and lost energy in detail, starting from the real-time value, yesterday's value, the current value to the last month, and the last month's usage value, are displayed on the Overview menu. The overview display is equipped with a chart of energy consumption and lost energy usage per hour and day.

Figure 5 represents data after testing the energy monitoring system for seven days. It was found that the average amount of energy consumption used through the PZEM-004T sensor module measurement was 16.39 kWh, and the average energy consumption through the MELCOINDA MS-98E electrical meter measurement was 15.86 kWh and the MELCOINDA MF-97E type was 16.12 kWh. Figure 6 explains the average accuracy value

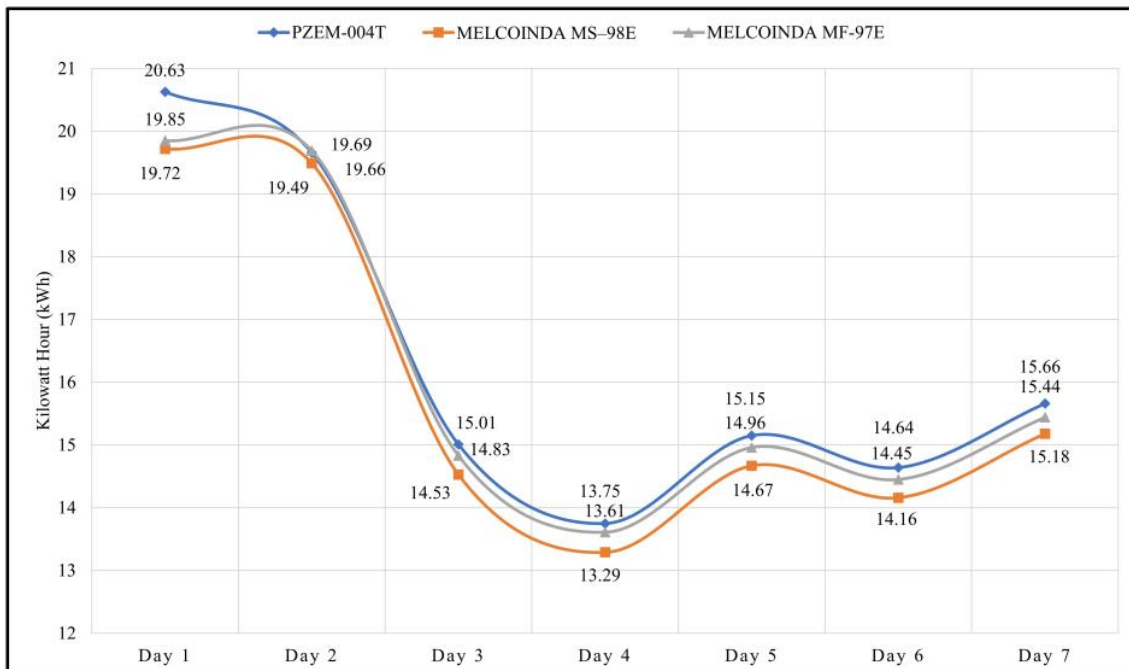

FIGURE 5. Energy consumption graph using three measurement devices with average value as 16.12 kWh in seven days

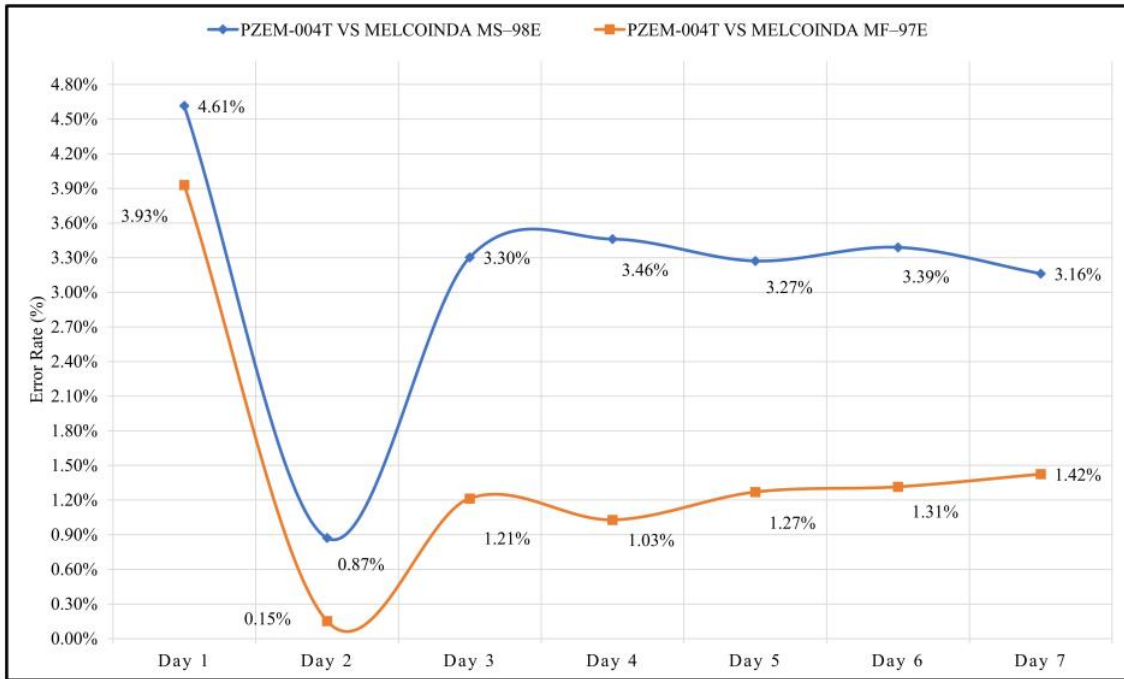

FIGURE 6. Error rate graph with average value as 2.31%

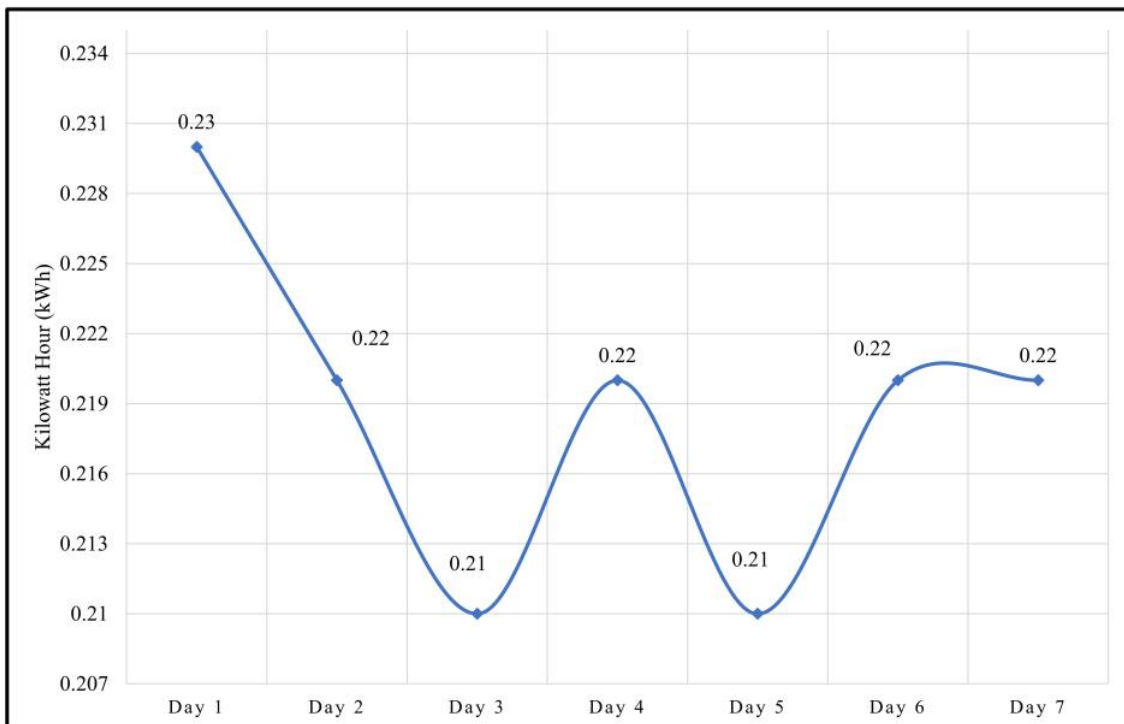

FIGURE 7. Lost energy consumption graph using PZEM-004T module sensor

based on the error rate of the PZEM-004T sensor module for the MELCOINDA MS-98E type electrical meter is 3.15% and for the MELCOINDA MF-97E type as a validation reference for the PZEM-004T sensor module, the average error rate value is quite smaller which is about 1.48%.

Figure 7 described the test results from measuring the value of energy lost for seven days using the PZEM-004T sensor module, and obtained an average value of 0.22 kWh.

4. Conclusions. This research has succeeded in developing a monitoring system for energy consumption and lost energy using the PZEM-004T sensor based on the IoT. The results of the sensor accuracy test were obtained with an average error rate of 2.31% from the validation results by two electrical meter units with type MELCOINDA MF-97E and MELCOINDA MS-98E. This monitoring system has an accuracy of truth in detecting energy consumption of 97.69%. EMS detects an average kWh value for seven days of 0.22 kWh for lost energy. This system can be implemented in real terms as a flexible monitoring tool for electricity energy consumption and lost energy. In future research, it can be tried to use other power sensors to increase the accuracy of readings in the energy monitoring system.

REFERENCES

- [1] *International – U.S. Energy Information Administration (EIA)*, <https://www.eia.gov/international/data/world>, Accessed on June 02, 2021.
- [2] *Global Electricity Consumption Continues to Rise Faster Than Population – Today in Energy – U.S. Energy Information Administration (EIA)*, <https://www.eia.gov/todayinenergy/detail.php?id=44095>, Accessed on June 02, 2021.
- [3] *Everything to Know about Your Electric Meter – Blog – Residential & Commercial Heating & Cooling Insights*, <https://greatercomfort.com/blog/cincinnati-heating-and-cooling/everything-to-know-about-your-electric-meter/>, Accessed on June 02, 2021.
- [4] *How to Read Your Electric Meter: An Energy Use Guide – Chariot Energy*, <https://chariotenergy.com/chariot-university/read-your-electric-meter-energy-consumption-guide/>, Accessed on June 02, 2021.
- [5] *What Is an Electric Meter?*, Enertiv-Smart Building Technology & Submetering Solutions, <https://www.enertiv.com/resources/faq/what-is-electric-meter>, Accessed on June 02, 2021.
- [6] Donnelly Mechanical, *5 Sources for Energy Loss in Commercial Buildings*, 2017, <https://donnelly-mech.com/blog/5-common-sources-for-energy-loss-in-commercial-buildings/>, Accessed on June 02, 2021.
- [7] J. Schonek, How big are power line losses?, *Schneider Electric Blog*, March 25, 2013, <https://blog.se.com/energy-management-energy-efficiency/2013/03/25/how-big-are-power-line-losses/>, Accessed on June 02, 2021.
- [8] *Lost in Transmission: How Much Electricity Disappears between a Power Plant and Your Plug?*, Inside Energy, <http://insideenergy.org/2015/11/06/lost-in-transmission-how-much-electricity-disappears-between-a-power-plant-and-your-plug/>, Accessed on June 02, 2021.
- [9] E. Palantei et al., 6 monopole elements array intelligent antennas for IoT based environmental surveillance network, *EPI Int. J. Eng.*, vol.3, no.2, pp.126-131, doi: 10.25042/epi-ije.082020.06, 2021.
- [10] K. Xia, J. Ni, Y. Ye, P. Xu and Y. Wang, A real-time monitoring system based on ZigBee and 4G communications for photovoltaic generation, *CSEE J. Power Energy Syst.*, doi: 10.17775/CSEE-JPES.2019.01610, 2020.
- [11] R. Morello, C. D. Capua, G. Fulco and S. C. Mukhopadhyay, A smart power meter to monitor energy flow in smart grids: The role of advanced sensing and IoT in the electric grid of the future, *IEEE Sens. J.*, vol.17, no.23, pp.7828-7837, doi: 10.1109/JSEN.2017.2760014, 2017.
- [12] L. Zhao, S. Qu, J. Zeng and Q. Zhao, Energy-saving and management of telecom operators, remote computer rooms using IoT technology, *IEEE Access*, vol.8, pp.166197-166211, doi: 10.1109/ACCESS.2020.3022641, 2020.
- [13] H. Ko, S. Pack and V. C. M. Leung, Spatiotemporal correlation-based environmental monitoring system in energy harvesting Internet of Things (IoT), *IEEE Trans. Ind. Inform.*, vol.15, no.5, pp.2958-2968, doi: 10.1109/TII.2018.2889778, 2019.
- [14] A. Hendra, E. Palantei, Syafaruddin, M. S. Hadis, N. Zulkarnaim and M. F. Mansyur, Wireless sensor network implementation for IoT-based environmental security monitoring, *IOP Conf. Ser. Mater. Sci. Eng.*, vol.875, doi: 10.1088/1757-899X/875/1/012093, 2020.
- [15] Muliadi, M. Y. Fahrezi, I. S. Areni, E. Palantei and A. Achmad, A smart home energy consumption monitoring system integrated with Internet connection, *2020 IEEE International Conference on Communication, Networks and Satellite (Commnetsat)*, pp.75-80, doi: 10.1109/Commnetsat50391.2020.9328960, 2020.

- [16] S.-C. Wang, Y.-L. Lin, M.-L. Chiang and H.-H. Pan, Improve the stability of the Internet of Things using dynamic load balancing clustering, *International Journal of Innovative Computing, Information and Control*, vol.16, no.1, pp.63-76, doi: 10.24507/ijicic.16.01.63, 2020.
- [17] S. H. M. S. Andrade, G. O. Contente, L. B. Rodrigues, L. X. Lima, N. L. Vijaykumar and C. R. L. Frances, A smart home architecture for smart energy consumption in a residence with multiple users, *IEEE Access*, vol.9, pp.16807-16824, doi: 10.1109/ACCESS.2021.3051937, 2021.
- [18] E. Al-Hassan, H. Shareef, Md. M. Islam, A. Wahyudie and A. A. Abdrabou, Improved smart power socket for monitoring and controlling electrical home appliances, *IEEE Access*, vol.6, pp.49292-49305, doi: 10.1109/ACCESS.2018.2868788, 2018.
- [19] S. Gan, K. Li, Y. Wang and C. Cameron, IoT based energy consumption monitoring platform for industrial processes, *2018 UKACC 12th International Conference on Control (CONTROL)*, pp.236-240, doi: 10.1109/CONTROL.2018.8516828, 2018.
- [20] L. Susanti, D. Fatrias, D. Ichwana, H. Kamil and M. V. Putri, A configuration system for real-time monitoring and controlling electricity consumption behavior, *2018 International Conference on Information Technology Systems and Innovation (ICITSI)*, pp.442-447, doi: 10.1109/ICITSI.2018.8696022, 2018.
- [21] S. Wasoontarajaroen, K. Pawasan and V. Chamnanphrai, Development of an IoT device for monitoring electrical energy consumption, *2017 9th International Conference on Information Technology and Electrical Engineering (ICITEE)*, pp.1-4, doi: 10.1109/ICITEED.2017.8250475, 2017.
- [22] Admin, Get to know PZEM-004T electronic modules for electrical measurement tools, *NN Digital | Learn Arduino, ESP8266 / NodeMCU, STM32, Raspberry Pi, Microcontroller and Other Information Technology*, August 07, 2019, <https://www.nn-digital.com/en/blog/2019/08/07/get-to-know-pzem-004t-electronic-modules-for-electrical-measurement-tools/>, Accessed on June 02, 2021.
- [23] WeMos D1 Mini ESP8266 development board, *Open Impulse*, <https://www.openimpulse.com/blog/products-page/product-category/wemos-d1-mini-esp8266-development-board/>, Accessed on June 02, 2021.
- [24] M. Rizal, M. S. Hadis, R. Angriawan and A. Arifin, Bluetooth performance evaluation of ESP32 module in line of sight environment, *J. Embed. Syst. Secur. Intell. Syst.*, vol.1, no.1, pp.42-47, 2020.

● **4% Overall Similarity**

Top sources found in the following databases:

- 3% Internet database
- Crossref database
- 1% Submitted Works database
- 2% Publications database
- Crossref Posted Content database

TOP SOURCES

The sources with the highest number of matches within the submission. Overlapping sources will not be displayed.

1	icicel.org Internet	2%
2	Elyas Palantei, Dewiani, Asrul Ramadhan, Sigit Lukman. "A Smart Card... Crossref	<1%
3	mdpi-res.com Internet	<1%
4	Baek, Hyun, and Sun-Kyoung Park. "Sustainable Development Plan for ... Crossref	<1%

● Excluded from Similarity Report

- Bibliographic material
- Cited material
- Manually excluded sources
- Quoted material
- Small Matches (Less than 10 words)

EXCLUDED SOURCES

repository.unhas.ac.id

Internet

9%